

# Range

## Use and Care Guide

### Table of Contents



**Important Safety Instructions** ..... 1-3



**Care & Cleaning** ..... 4-6  
Self-Clean Oven  
Cleaning Procedures



**Maintenance** ..... 7  
Oven Window  
Oven Light



**Troubleshooting** ..... 8



**Surface Cooking** ..... 9-12

Surface Controls  
Warming Center  
Smoothtop Surface



**Oven Cooking** ..... 12-18

Baking	Broiling
Cook & Hold	Sabbath Mode
Delay Cook & Hold	Favorite
Keep Warm	Oven Racks



**Warranty & Service** ..... 19

**Installer:** Please leave this guide with this appliance.

**Consumer:** Please read and keep this guide for future reference. Keep sales receipt and/or canceled check as proof of purchase.

Model Number \_\_\_\_\_

Serial Number \_\_\_\_\_

Date of Purchase \_\_\_\_\_

If you have questions, call:  
Customer Assistance  
1-800-688-9900 USA  
1-800-688-2002 Canada  
1-800-688-2080 (U.S. TTY for hearing or speech impaired)  
(Mon.-Fri., 8 am-8 pm Eastern Time)  
Internet: <http://www.maytag.com>

In our continuing effort to improve the quality and performance of our cooking products, it may be necessary to make changes to the appliance without revising this guide.

**For service information, see page 19.**

technician. **Do not** attempt to adjust, repair, service, or replace any part of your appliance unless it is specifically recommended in this guide. All other servicing should be referred to a qualified servicer.

Always disconnect power to appliance *before* servicing.

## WARNING

- **ALL RANGES CAN TIP AND CAUSE INJURIES TO PERSONS**
- **INSTALL ANTI-TIP DEVICE PACKED WITH RANGE**
- **FOLLOW ALL INSTALLATION INSTRUCTIONS**



**WARNING:** To reduce risk of tipping of the appliance from abnormal usage or by excessive loading of the oven door, the appliance must be secured by a properly installed anti-tip device.

To check if device is properly installed, look underneath range with a flashlight to make sure one of the rear leveling legs is properly engaged in the bracket slot. The anti-tip device secures the rear leveling leg to the floor when properly engaged. You should check this **anytime** the range has been moved.

## To Prevent Fire or Smoke Damage

Be sure all packing materials are removed from the appliance *before* operating it.

Keep area around appliance clear and free from combustible materials. Flammable materials **should not** be stored in an oven.

Many plastics are vulnerable to heat. Keep plastics away from parts of the appliance that may become warm or hot.

To prevent grease fires, **do not** let cooking grease or other flammable materials accumulate in or near the appliance.

## In Case of Fire

Use dry chemical or foam-type extinguisher or baking soda to smother fire or flame. **Never** use water on a grease fire.

1. Turn off appliance to avoid spreading the flame.
2. **NEVER** pick up or move a flaming pan.
3. Smother fire or flame by closing the oven door.

Turn off appliance and ventilating hood to avoid spreading the flame. Extinguish flame, then turn on hood to remove smoke and odor.

## Important Safety Instructions

Warning and Important Safety Instructions appearing in this guide are not meant to cover all possible conditions and situations that may occur. Common sense, caution, and care must be exercised when installing, maintaining, or operating the appliance.

Always contact the manufacturer about problems or conditions you do not understand.

### Recognize Safety Symbols, Words, Labels

#### WARNING

**WARNING** – Hazards or unsafe practices which COULD result in severe personal injury or death.

#### CAUTION

**CAUTION** – Hazards or unsafe practices which COULD result in minor personal injury.

**Read and follow all instructions *before* using this appliance** to prevent the potential risk of fire, electric shock, personal injury or damage to the appliance as a result of improper usage of the appliance. Use appliance only for its intended purpose as described in this guide.

**To ensure proper and safe operation:** Appliance must be properly installed and grounded by a qualified

## Child Safety

### CAUTION

**NEVER** store items of interest to children in cabinets above an appliance. Children climbing on the appliance or on the appliance door to reach items could be seriously injured.

**NEVER** leave children alone or unsupervised near the appliance when it is in use or is still hot. Children should **never** be allowed to sit or stand on any part of the appliance as they could be injured or burned.

Children must be taught that the appliance and utensils in it can be hot. Let hot utensils cool in a safe place, out of reach of small children. Children should be taught that an appliance is not a toy. Children **should not** be allowed to play with controls or other parts of the appliance.

## About Your Appliance

### CAUTION

**NEVER** use an appliance as a step to reach cabinets above. Misuse of appliance door, such as stepping, leaning or sitting on the door, may result in possible tipping of the appliance, breakage of door, and serious injuries.

To prevent potential hazard to the user and damage to the appliance, **do not** use appliance as a space heater to heat or warm a room. Also, do not use the oven as a storage area for food or cooking utensils.

**Do not** obstruct the flow of air by blocking the oven vent.

**DO NOT TOUCH HEATING ELEMENTS OR INTERIOR SURFACES OF OVEN.** Heating elements may be hot even though they are dark in color. Interior surfaces of any oven become hot enough to cause burns. During and after use, **do not** touch, or let clothing or other flammable materials contact heating elements or interior surfaces of oven until they have had sufficient time to cool. Other surfaces of the appliance may become hot enough to cause burns – among these surfaces are: oven vent opening and surface near this opening, oven door, window of oven door.

**Do not** touch a hot oven light bulb with a damp cloth as the bulb could break. Should the bulb break, disconnect power to the appliance *before* removing bulb to avoid electrical shock.

**NEVER** use aluminum foil to cover an oven rack or oven bottom. Misuse could result in risk of electric shock, fire, or damage to the appliance. Use foil only as directed in this guide.

## Cooking Safety

**Never** heat an unopened food container in the oven. Pressure build-up may cause container to burst resulting in serious personal injury or damage to the appliance.

Use dry, sturdy potholders. Damp potholders may cause burns from steam. Dish towels or other substitutes should **never** be used as potholders because they can trail across hot elements and ignite or get caught on appliance parts.

Wear proper apparel. Loose fitting or long hanging-sleeved apparel **should not** be worn while cooking. Clothing may ignite and cause burns if garment comes in contact with heating elements.

Always place oven racks in the desired positions while oven is cool. Slide oven rack out to add or remove food, using dry, sturdy potholders. Always avoid reaching into the oven to add or remove food. If a rack must be moved while hot, use a dry potholder. **Do not** let potholder contact hot element in oven.

Use racks only in the oven in which they were shipped/purchased.

Use care when opening the oven door. Let hot air or steam escape before removing or replacing food.

**PREPARED FOOD WARNING:** Follow food manufacturer's instructions. If a plastic frozen food container and/or its cover distorts, warps, or is otherwise damaged during cooking, immediately discard the food and its container. The food could be contaminated.

**Do not** allow aluminum foil or meat probe to contact heating element.

Always turn off all controls when cooking is completed.

## Utensil Safety

Follow the manufacturer's directions when using oven cooking bags.

This appliance has been tested for safe performance using conventional cookware. **Do not** use any devices or accessories that are not specifically recommended in this guide. **Do not** use add-on oven convection systems. The use of devices or accessories that are not expressly recommended in this guide can create serious safety hazards, result in performance problems, and reduce the life of the components of the appliance.

If pan is smaller than element, a portion of the element will be exposed to direct contact and could ignite clothing or potholder.

Only certain types of glass, glass/ceramic, ceramic, earthenware, or other glazed utensils are suitable for cooktop or oven service without breaking due to the sudden change in temperature. Follow utensil manufacturer's instructions when using glass.

Turn pan handle toward center of cooktop, not out into the room or over another surface element. This reduces the risk of burns, ignition of flammable materials, or spillage if pan is accidentally bumped or reached by small children.

## Cooktop

**NEVER** leave surface units unattended especially when using high heat. An unattended boilover could cause smoking and a greasy spillover can cause a fire.

This appliance is equipped with different sized surface elements. Select pans with flat bottoms large enough to cover element. Fitting pan size to element will improve cooking efficiency.

**GLASS-CERAMIC SURFACE: NEVER** cook on broken cooktop. If cooktop should break, cleaning solutions and spillovers may penetrate the broken cooktop and create a risk of electric shock. Contact a qualified technician immediately.

## Deep Fat Fryers

Use extreme caution when moving the grease pan or disposing of hot grease. Allow grease to cool *before* attempting to move pan.

## Ventilating Hoods

Clean range hood and filters frequently to prevent grease or other flammable materials from accumulating on hood or filter and to avoid grease fires.

When flaming foods under the hood, turn the fan on.

## Cleaning Safety

Clean cooktop with caution. Turn off all controls and wait for appliance parts to cool *before* touching or cleaning. Clean with caution. Use care to avoid steam burns if a wet sponge or cloth is used to wipe spills on a hot surface. Some cleaners can produce noxious fumes if applied to a hot surface.

Clean only parts listed in this guide.

## Self-Clean Oven



*Before* self-cleaning the oven, remove the oven racks, broiler pan, food and any other utensils. Wipe spillovers to prevent excessive smoke and flare-ups.

**Do not** clean door gasket. The door gasket is essential for a good seal. Care should be taken not to rub, damage, or move the gasket.

**Do not** use oven cleaners or oven liners of any kind in or around any part of the self-clean oven.

## Important Safety Notice and Warning

The California Safe Drinking Water and Toxic Enforcement Act of 1986 (Proposition 65) requires the Governor of California to publish a list of substances known to the State of California to cause cancer or reproductive harm, and requires businesses to warn customers of potential exposures to such substances.

Users of this appliance are hereby warned that when the oven is engaged in the self-clean cycle, there may be some low-level exposure to some of the listed substances, including carbon monoxide. Exposure to these substances can be minimized by properly venting the oven to the outdoors by opening the windows and/or door in the room where the appliance is located during the self-clean cycle.

**IMPORTANT NOTICE REGARDING PET BIRDS: Never** keep pet birds in the kitchen or in rooms where the fumes from the kitchen could reach. Birds have a very sensitive respiratory system. Fumes released during an oven self-cleaning cycle may be harmful or fatal to birds. Fumes released due to overheated cooking oil, fat, margarine and overheated non-stick cookware may be equally harmful.

## Save These Instructions for Future Reference

## Self-Clean Oven

### CAUTION

- It is normal for parts of the range to become hot during a self-clean cycle.
- To prevent damage to oven door, **do not** attempt to open the door when LOCK is displayed.
- Avoid touching cooktop, door, window or oven vent area during a clean cycle.
- **Do not** use commercial oven cleaners on the oven finish or around any part of the oven. They will damage the finish or parts.

The self-clean cycle uses above-normal cooking temperatures to automatically clean the oven interior.

The oven should be cleaned regularly by wiping up spillovers to prevent excessive smoke and flare-ups. **Do not** allow a heavy build-up of soil to accumulate in the oven.

During the cleaning process, the kitchen should be well ventilated to get rid of normal odors associated with cleaning.

### Before Self-Cleaning

1. Turn off the oven light *before* cleaning. The light may burn out during the clean cycle.
2. Remove all pans and oven racks from the oven. The oven racks will discolor and may not slide easily after a self-clean cycle if they are not removed.
3. Clean oven frame, door frame, area outside of gasket, and around the opening in the door gasket with a nonabrasive cleaner such as Bon Ami\* or detergent and water. The self-cleaning process does not clean these areas. They should be cleaned to prevent soil from baking on during the clean cycle. (The gasket is the seal around the oven door and window.)
4. To prevent damage, **do not** clean or rub the gasket around the oven door. The gasket is designed to seal in heat during the clean cycle.
5. Wipe up excess grease or spillovers from the oven bottom. This prevents excessive smoking, flare-ups or flaming during the clean cycle.
6. Wipe up sugary and acidic spillovers such as sweet potatoes, tomato, or milk-based sauces. Porcelain enamel is acid-resistant, not acid-proof. The porcelain finish may discolor if acidic spills are not wiped up *before* a self-clean cycle.

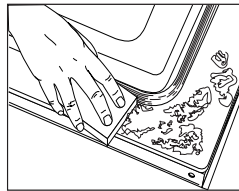

### To set Self-Clean:

**Important:** Oven temperature must be below 400° F to program a clean cycle.

1. Close the oven door.
2. Press the **Clean** pad.
  - CLEAN flashes in the display.
3. Press the **More+** or **Less-** pad.
  - MEd (Medium soil, 3 hours) is displayed.





If the door is not closed, beeps will sound and “door” will display. If the door is not closed within 45 seconds, the self-cleaning operation will be canceled and the display will return to the time of day.

4. Press the **More+** or **Less-** pad to scroll through the self-cleaning settings.

HVy (Heavy Soil, 4 hours)

MEd (Medium soil, 3 hours)

LITE ( Light Soil, 2 hours)

Choosing the soil level of the oven automatically programs the self-cleaning time.

5. After four seconds, the oven will start cleaning.
  - The cleaning time will start counting down in the display.
  - LOCK will appear in the display.
  - CLEAN will appear in the display.

### To Delay a Self-Clean Cycle:

1. Press the **Clean** and **Timer** pads.
  - DELAY and 00:00 will appear in the display.
2. Press the **More+** or **Less-** pad to set the amount of time you want to delay the cycle. Delay time can be set from ten minutes (00:10) to 11 hours, 59 minutes (11:59).
3. Press the **Clean** pad.
  - CLEAN will flash.
4. Press the **More+** or **Less-** pad.
  - MEd (Medium soil, 3 hours) is displayed.
5. Press the **More+** or **Less-** pad to scroll through the self-cleaning settings.
  - HVy (Heavy Soil, 4 hours)
  - MEd (Medium soil, 3 hours)
  - LITE ( Light Soil, 2 hours)



Choosing the soil level of the oven automatically programs the self-cleaning time.

**Cont.**

\* Brand names for cleaning products are registered trademarks of the respective manufacturers.

6. After four seconds, CLEAN, DELAY and LOCK will appear in the display to show that the oven is set for a delayed clean operation. The delay time is displayed.



### If the oven has already been set for a clean cycle and you wish to set a delay:

1. Press the **Clean** and **Timer** pads. (Press the **Clean** pad first)
  - DELAY flashes.
  - 00:00 will appear in the display.

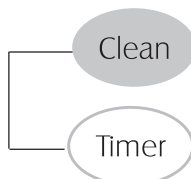

2. Press the **More+** or **Less-** pad to set the amount of time you want to delay the cycle.

After four seconds, CLEAN, DELAY and LOCK will appear in the display to show that the oven is set for a delayed clean operation. The delay time is displayed.

### When the Self-Clean cycle starts:

- DELAY will turn off.
- The clean time will appear in the display.

### To cancel the Self-Clean cycle:

Press the **CANCEL** pad.

- All words disappear from the display.
- All functions are canceled.
- The time of day appears in the display.



### During the Self-Clean Cycle

When LOCK shows in the display, the door cannot be opened. To prevent damage to the door, **do not** force the door open when LOCK is displayed.

### Smoke and Smells

You may see some smoke and smell an odor the first few times the oven is cleaned. This is normal and will lessen in time.

Smoke may also occur if the oven is heavily soiled or if a pan was left in the oven.

### Sounds

As the oven heats, you may hear sounds of metal parts expanding and contracting. This is normal and will not damage the oven.

### After Self-Cleaning

About one hour after the end of the self-clean cycle, LOCK will turn off. The door can then be opened.

**Some soil may leave a light gray, powdery ash.** Remove it with a damp cloth. If soil remains after wiping, that means the clean cycle was not long enough. The soil will be removed during the next clean cycle.

**If oven racks were left in the oven and do not slide smoothly after a clean cycle**, wipe racks and rack supports with a small amount of vegetable oil to make them easier to move.

**Fine lines may appear in the porcelain because it went through heating and cooling.** This is normal and will not affect performance.

**A white discoloration may appear after cleaning if acidic or sugary foods were not wiped up before the self-clean cycle.** This discoloration is normal and will not affect performance.

### Notes:

- If the oven door is left open, “door” will flash in the display and a signal will beep until the door is closed and the Clean pad is pressed again.
- If more than five seconds elapse between pressing the Clean pad and the More+ or Less- pads, the program will automatically return to the previous display.
- The oven door will be damaged if the oven door is forced to open when LOCK is still displayed.

## Cleaning Procedures

### CAUTION

- **Be sure appliance is off and all parts are cool before handling or cleaning. This is to avoid damage and possible burns.**
- To prevent staining or discoloration, clean appliance after each use.
- If a part is removed, be sure it is correctly replaced.

### Backguard and Cooktop – Porcelain Enamel

Porcelain enamel is glass fused on metal and may crack or chip with misuse. It is acid-resistant, not acid-proof. All spillovers, especially acidic or sugary spillovers, should be wiped up immediately with a dry cloth.

- When cool, wash with soapy water, rinse and dry.
- **Never** wipe off a warm or hot surface with a damp cloth. This may cause cracking or chipping.
- **Never** use oven cleaners, abrasive or caustic cleaning agents on exterior finish of range.

### Clock and Control Pad Area

- To activate control lock for cleaning, see *Locking the Controls*, page 13.
- Wipe with a damp cloth and dry. **Do not** use abrasive cleaning agents as they may scratch the surface.
- Glass cleaners may be used if sprayed on a cloth first. **DO NOT spray directly on control pad and display area.**

### Control Knobs

- Remove knobs in the OFF position by pulling forward.
- Wash, rinse and dry. **Do not** use abrasive cleaning agents as they may scratch the finish.

- Turn on each element to be sure the knobs have been correctly replaced.

### Cooktop – Glass-Ceramic

**Never use oven cleaners, chlorine bleach, ammonia or glass cleaners with ammonia. Important: Call an authorized servicer if the glass-ceramic top should crack, break or if metal or aluminum foil should melt on the cooktop.**

- Allow the cooktop to cool *before* cleaning.
- **General** – Clean cooktop after each use, or when needed, with a damp paper towel and Cooktop Cleaning Creme\* (Part No. 20000001)\*\*. Then, buff with a clean, dry cloth.  
**Important:** Permanent stains will develop if soil is allowed to cook on by repeatedly using the cooktop when soiled.
- **Heavy Soils or Metal Marks** – Dampen a “scratchless” or “never scratch” scrubber sponge. Apply Cooktop Cleaning Creme\* (Part No. 20000001)\*\* and scrub to remove as much soil as possible. Apply a thin layer of the creme over the soil, cover with a damp paper towel and let stand 30 to 45 minutes (2-3 hours for very heavy soil). Keep moist by covering the paper towel with plastic wrap. Scrub again, then buff with a clean, dry cloth.  
**Important:** Only use a CLEAN, DAMP “scratchless” pad that is safe for non-stick cookware. The pattern and glass will be damaged if the pad is not damp, if the pad is soiled, or if another type of pad is used.
- **Burned-on or Crusty Soils** – Scrub with a “scratchless” or “never scratch” scouring pad and Cooktop Cleaning Creme\*.

**Important:** Hold a razor blade scraper at 30° angle and scrape any remaining soil. Then, clean as described above. **Do not** use the razor blade for daily cleaning as it may wear the pattern on the glass.

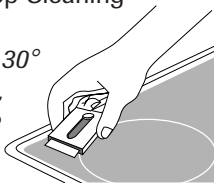

- **Melted Sugar or Plastic** – Immediately turn element to **LOW** and scrape sugar or plastic from hot surface to a cool area. Then turn element **OFF** and allow to cool. Clean residue with razor blade scraper and Cooktop Cleaning Creme\*.

### Oven Window and Door – Glass

- Avoid using excessive amounts of water which may seep under or behind glass, causing staining.
- Wash with soap and water. Rinse with clear water and dry. Glass cleaner can be used if sprayed on a cloth first.
- **Do not** use abrasive materials such as scouring pads, steel wool or powdered cleaners as they will scratch glass.

\* Brand names are registered trademarks of the respective manufacturers.

\*\* To order call 1-877-232-6771 USA and 1-800-688-8408 Canada.

### Oven Interior

- Follow instructions on pages 4-5 to set a self-clean cycle.

### Oven Racks

- Clean with soapy water.
- Remove stubborn soil with cleansing powder or soap-filled scouring pad. Rinse and dry.
- Racks will permanently discolor and may not slide smoothly if left in the oven during a self-clean operation. If this occurs, wipe the rack edge and rack support with a small amount of vegetable oil to restore ease of movement, then wipe off excess oil.

### Stainless Steel (select models)

- **DO NOT USE ANY CLEANING PRODUCT CONTAINING CHLORINE BLEACH.**
- **DO NOT USE ABRASIVE OR ORANGE CLEANERS.**
- **ALWAYS WIPE WITH THE GRAIN WHEN CLEANING.**
- **Daily Cleaning/Light Soil** -- Wipe with one of the following - soapy water, white vinegar/water solution, Formula 409 Glass and Surface Cleaner\* or a similar glass cleaner - using a sponge or soft cloth. Rinse and dry. To polish and help prevent fingerprints, follow with Stainless Steel Magic Spray\* (Part No. 20000008)\*\*.
- **Moderate/Heavy Soil** -- Wipe with one of the following - Bon Ami\*, Smart Cleanser\*, or Soft Scrub\* - using a damp sponge or soft cloth. Rinse and dry. Stubborn soils may be removed with a damp multi-purpose Scotch-Brite\* pad; rub evenly with the grain. Rinse and dry. To restore luster and remove streaks, follow with Stainless Steel Magic Spray\*.
- **Discoloration** -- Using a damp sponge or soft cloth, wipe with Cameo Stainless Steel Cleaner\*. Rinse immediately and dry. To remove streaks and restore luster, follow with Stainless Steel Magic Spray\*.

### Storage Drawer, Door Handle, Side Panels – Painted Enamel

- When cool, wash with warm soapy water, rinse and dry. **Never** wipe a warm or hot surface with a damp cloth as this may damage the surface and may cause a steam burn.
- For stubborn soil, use mildly abrasive cleaning agents such as baking soda paste or Bon Ami.\* **Do not** use abrasive, caustic or harsh cleaning agents such as steel wool pads or oven cleaners. These products will scratch or permanently damage the surface.

**Important: Use a dry towel or cloth to wipe up spills, especially acidic or sugary spills. Surface may discolor or dull if soil is not immediately removed. This is especially important for white surfaces.**

## Oven Door

### ! CAUTION

**Do not** place excessive weight on or stand on an open oven door. This could cause the range to tip over, break the door, or injure the user.

**Important:** The oven door on a new range may feel “spongy” when it is closed. This is normal and will decrease with use.

## Oven Window

### To protect the oven door window:

1. **Do not** use abrasive cleaning agents such as steel wool scouring pads or powdered cleansers as they may scratch the glass.
2. **Do not** hit the glass with pots, pans, furniture, toys, or other objects.
3. **Do not** close the oven door until the oven racks are in place.

Scratching, hitting, jarring or stressing the glass may weaken its structure causing an increased risk of breakage at a later date.

## Oven Light

### ! CAUTION

- Disconnect power to range *before* replacing light bulb.
- Allow oven to cool *before* replacing light bulb.
- Make sure bulb cover and bulb are cool *before* touching.

### To replace oven light bulb:

1. When oven is cool, hold bulb cover in place, then slide wire retainer off cover. **Important:** Bulb cover will fall if not held in place while removing wire retainer.
2. Remove bulb cover and light bulb.
3. Replace with a 40-watt appliance bulb.
4. Replace bulb cover and secure with wire retainer.
5. Reconnect power to range. Reset clock.

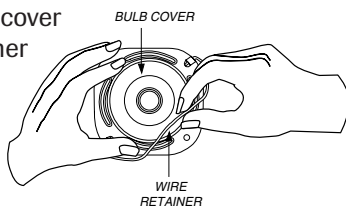

## Leveling Legs

### ! CAUTION

Be sure the anti-tip bracket secures one of the rear leveling legs to the floor. This bracket prevents the range from accidentally tipping.

Be sure the range is leveled when installed. If the range is not level, turn the leveling legs, located at each corner of the range, until range is level.

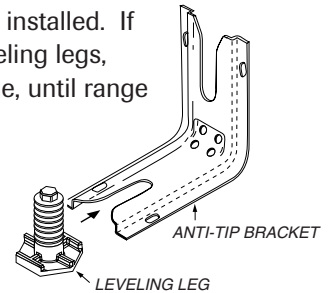

## Storage Drawer

### ! CAUTION

**Do not** store plastic, paper products, food or flammable materials in this drawer. The drawer may become too warm for these items when the oven is in use.

The storage drawer can be removed to allow you to clean under the range.

### To remove:

1. Empty drawer and pull out to the first stop position.
2. Lift up the front of the drawer.
3. Pull out to the second stop position.
4. Grasp sides and lift drawer up and out.

### To replace:

1. Fit the ends of the drawer glides into the rails in the range.
2. Lift up the front of the drawer and gently push in to the first stop position.
3. Lift drawer up again and push until drawer is closed.

## Convenience Outlet (Canadian models only)

The convenience outlet is located on the lower left side of the backguard. Be sure appliance cords do not rest on or near the surface element. If the surface element is turned on, the cord and outlet will be damaged.

The convenience outlet circuit breaker may trip if the small appliance plugged into it exceeds 10 amps. To reset the circuit breaker, press the switch located on the lower edge of the backguard.

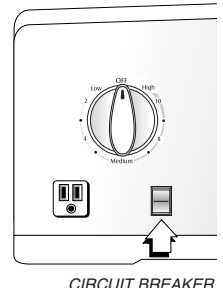

# Troubleshooting

## **For most concerns, try these first.**

- Check if oven controls have been properly set.
- Check to be sure plug is securely inserted into receptacle.
- Check or re-set circuit breaker. Check or replace fuse.
- Check power supply.

## **Part or all of appliance does not work.**

- Check if surface and/or oven controls have been properly set. See pages 9 & 12.
- Check if oven door is unlocked after self-clean cycle. See page 5.
- Check if oven is set for a delayed cook or clean program. See pages 4 & 14.
- Check if Control Lock is activated. See page 13.
- Check if control is in Sabbath Mode. See page 16.

## **Clock, indicator words, and/or lights operate but oven does not heat.**

- Oven may be set for a Cook & Hold or Delay function.
- The Control Lock may have been set. See page 13.

## **Baking results are not as expected or differ from previous oven.**

- Make sure the oven vent has not been blocked. See page 17 for location.
- Check to make sure range is level.
- Temperatures often vary between a new oven and an old one. As ovens age, the oven temperature often “drifts” and may become hotter or cooler. See page 16 for instructions on adjusting the oven temperature. **Important:** It is not recommended to adjust the temperature if only one or two recipes are in question.

## **Food is not broiling properly or smokes excessively.**

- Check oven rack positions. Food may be too close to element.
- Broil element was not preheated.
- Aluminum foil was incorrectly used. **Never** line the broiler insert with foil.
- Oven door was closed during broiling. Leave the door open to the first stop position (about 4 inches).
- Trim excess fat from meat *before* broiling.
- A soiled broiler pan was used.
- Voltage in house may be low.

## **Oven will not self-clean.**

- Check to make sure the cycle is not set for a delayed start. See page 4.
- Check if door is closed.
- Check if control is in Sabbath Mode. See page 16.
- Oven may be over 400° F. Oven temperature must be below 400° F to program a clean cycle.

## **Oven did not clean properly.**

- Longer cleaning time may be needed.
- Excessive spillovers, especially sugary and/or acidic foods, were not removed prior to the self-clean cycle.

## **Smoothtop surface shows wear.**

- Tiny scratches or abrasions.
  - Make sure cooktop and pan bottom are clean. **Do not** slide glass or metal pans across top. Make sure pan bottom is not rough. Use the recommended cleaning agents. See page 6.

- Metal marks.
  - **Do not** slide metal pans across top. When cool, clean with Cooktop Cleaning Creme. See page 6.
- Brown streaks and specks.
  - Remove spills promptly. **Never** wipe with a soiled cloth or sponge. Make sure cooktop and pan bottom are clean.
- Areas with a metallic sheen.
  - Mineral deposits from water and food. Use recommended cleaning agents. See page 6.
- Pitting or flaking.
  - Remove sugary boilovers promptly. See page 6.

## **Moisture collects on oven window or steam comes from oven vent.**

- This is normal when cooking foods high in moisture.
- Excessive moisture was used when cleaning the window.

## **There is a strong odor or light smoke when oven is turned on.**

- This is normal for a new range and will disappear after a few uses. Initiating a clean cycle will “burn off” the odors more quickly.
- Turning on a ventilation fan will help remove the smoke and/or odor.
- Excessive food soils on the oven bottom. Use a self-clean cycle.

## **Fault Codes**

- BAKE or LOCK may flash rapidly in the display to alert you if there is an error or a problem. If BAKE or LOCK appear in the display, press **CANCEL** pad. If BAKE or LOCK continue to flash, disconnect power to the appliance. Wait a few minutes, and then reconnect power. If the flashing still continues, disconnect power to the appliance and call an authorized servicer.
- If the oven is heavily soiled, excessive flareups may result in a fault code during cleaning. Press the **CANCEL** pad and allow the oven to cool completely, wipe out excess soil, then reset the clean cycle. If the fault code reappears, contact an authorized servicer.

## **Noises may be heard.**

- The oven makes several low level noises. You may hear the oven relays as they go on and off. This is normal.
- As the oven heats and cools, you may hear sounds of metal parts expanding and contracting. This is normal and will not damage your appliance.

## **There are no beeps and no display.**

- Oven may be in Sabbath Mode. See page 16.

## **SAb flashing and then displayed continuously.**

- Oven is in Sabbath Mode. To cancel, press and hold the **Clock** pad for *five* seconds.
- Excessive spillovers, especially sugary and/or acidic foods, were not removed prior to the self-clean cycle.

## **Oven door will not unlock after self-clean cycle.**

- Oven interior is still hot. Allow about one hour for the oven to cool after the completion of a self-clean cycle. The door can be opened when the LOCK indicator word is not displayed.
- The control and door may be locked. See page 5.



# Surface Cooking

## Surface Controls

Use to turn on the surface elements. An infinite choice of heat settings is available from Low to High. The knobs can be set on or between any of the settings.

## Setting the Controls

1. Place pan on surface element.
2. Push in and turn the knob in either direction to the desired heat setting.
  - The control panel is marked to identify which element the knob controls. For example, the graphic at right indicates left front element.
3. There is an element indicator light on the control panel. When any surface control knob is turned on, the light will turn on. The light will turn off when all the surface elements are turned off.



When a control is turned on, a glow can be seen through the smoothtop surface. The element will cycle on and off to maintain the preset heat setting, even on High.

4. After cooking, turn knob to **OFF**. Remove pan.

## Suggested Heat Settings

The size and type of cookware, type and amount of food being heated, and wattage of individual elements will determine where to set the knob for cooking operations. Some elements have a predetermined simmer and melt setting that will require only minor adjustment up or down depending on the food being prepared. The other elements have settings printed around the knobs that are also unique to those elements. Adjust the heat settings to the numbers that give the desired cooking results. For information on cookware and

other factors affecting heat settings, refer to *Cookware Recommendations* on page 11. The following descriptions will aid in choosing the settings that will give optimum results.

**Hold or Warm:** Food maintains a temperature above 140°F without continuing to cook. Food is initially hot and then heat is reduced. **Never** use a Hold or Warm setting to reheat cold food.

**Simmer:** Food forms bubbles that barely break the surface. Foods are between 185° F and 200° F. A simmer setting can also be used to steam or poach foods or continue cooking covered foods.

**Slow Boil:** Food forms bubbles at a moderate pace. A slow boil setting can also be used for most frying and for maintaining the cooking of large amounts of liquids.

**Boil:** Liquid forms bubbles at a rapid pace. A fast boil setting can also be used to brown meat, stir fry, sauté, and heat oil for frying before turning to a lower setting. The highest 3 or 4 settings on the knob are used for these cooking operations. The highest setting is always used to bring water to a boil. Some elements offer an even higher speed for boiling liquids.

## Dual Element

The cooking surface has a dual element located at the left front of the smoothtop. This allows you to change the size of this element.

Press the switch to the left to use the large element or to the right to use the small element. The selection should be made *before* turning on the element.

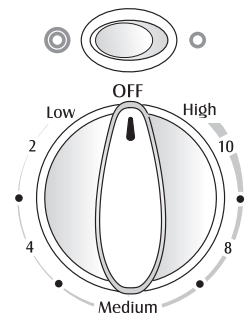

## ! CAUTION

### BEFORE COOKING

- Always place a pan on the surface unit *before* you turn it on. To prevent damage to range, **never** operate surface unit without a pan in place.
- **NEVER** use the cooktop as a storage area for food or cookware.

### DURING COOKING

- Be sure you know which knob controls which surface unit. Make sure you turned on the correct surface unit.
- Begin cooking on a higher heat setting then reduce to a lower setting to complete the operation. **Never** use a high heat setting for extended cooking.
- **NEVER** allow a pan to boil dry. This could damage the pan and the appliance.
- **NEVER** touch cooktop until it has cooled. Expect some parts of the cooktop, especially around the surface units, to become warm or hot during cooking. Use potholders to protect hands.

### AFTER COOKING

- Make sure surface unit is turned off.
- Clean up messy spills as soon as possible.

### OTHER TIPS

- If cabinet storage is provided directly above cooking surface, limit it to items that are infrequently used and can be safely stored in an area subjected to heat. Temperatures may be unsafe for items such as volatile liquids, cleaners or aerosol sprays.
- **NEVER** leave any items, especially plastic items, on the cooktop. The hot air from the vent may ignite flammable items, melt or soften plastics, or increase pressure in closed containers causing them to burst.
- **NEVER** allow aluminum foil, meat probes or any other metal object, other than a pan on a surface element, to contact heating elements.
- **NEVER** store heavy items above the cooktop that could fall and damage it.

## Triple Zone Element with Power Boost™ Option

The cooking surface has one triple element with Power Boost™ option located in the right front position. This element can be used for larger cooking utensils when the triple element is used, or for smaller pans when the single or dual settings are chosen.

To operate the single element only, use the left side of the control knob and select any setting from Low to High.

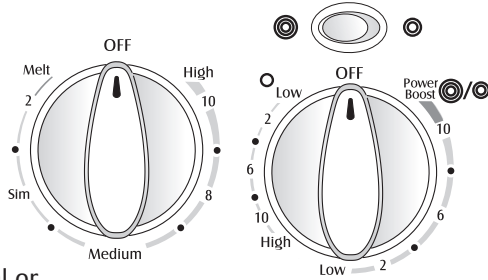

To operate the dual or triple elements, press the switch above the knob to the left for the triple element or to the right for the double element. Then, use the right side of the control knob to select any heat setting from Low to High.

## Power Boost™ Option

When the dual or triple elements are used, the Power Boost™ option can be selected. This setting offers higher speed cooking that can be used to quickly bring water to a boil and for large-quantity cooking.

## Flex-Choice™ Elements (select models)

The Flex-Choice™ elements are fully functioning elements that provide an ultra low Melt heat setting for melting chocolate and butter. They are located in the left and right rear positions.

The Melt setting is located between 2 and OFF. Heat settings outside of this area function as a normal element, with 2 (Low) to High settings.

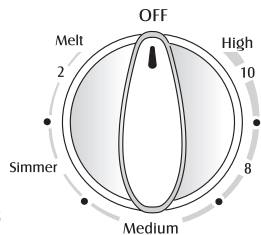

**Important:** When using the normal settings for preparing foods, it may take a few minutes for the cooking area to cool to the Melt heat setting.

## Warming Center

Use the Warming Center to keep hot cooked foods warm, such as vegetables, gravies and oven-safe dinner plates.

### Setting the Control:

1. Push in and turn the knob. Warming temperatures are approximate and are indicated on the control as Min, 2-8 and Max. However, the control can be set to any position between Min and Max.
2. When done, turn the control to **OFF** and remove food. The Hot Surface indicator light will go off when the Warming Center surface has cooled.

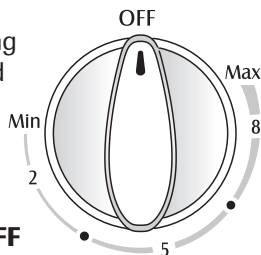

### Important:

- **Never** warm food for longer than one hour (eggs for 30 minutes), as food quality may deteriorate.

- **Do not** heat cold food on the Warming Center.
- Heat settings will vary depending on type and amount of food. Always hold food at proper food temperatures. USDA recommends food temperatures between 140°-170° F.

### Suggested Settings

Setting	Type of food	
<b>Min - 2</b>	Breads/Pastries Casseroles	Gravies Eggs
<b>2 - 5</b>	Dinner Plate with Food Soups (Cream) Vegetables	Sauces Stews Meats
<b>5 - Max</b>	Fried Foods Soups (Liquid)	Hot Beverages

### Notes:

- Use only cookware and dishes recommended as safe for oven and cooktop use.
- Always use oven mitts when removing food from the Warming Center as cookware and plates will be hot.
- All foods should be covered with a lid or aluminum foil to maintain food quality.
- When warming pastries and breads the cover should have an opening to allow moisture to escape.
- **Do not** use plastic wrap to cover foods. Plastic may melt on to the surface and be very difficult to clean.

## Smoothtop Surface

### Notes:

- **Cooktop may emit light smoke and odor** the first few times the cooktop is used. This is normal.
- **Smoothtop cooktops retain heat for a period of time after the element is turned off.** Turn the elements off a few minutes *before* food is completely cooked and use the retained heat to complete cooking. When the hot surface light turns off, the cooking area will be cool enough to touch. Because of the way they retain heat, the smoothtop elements will not respond to changes in settings as quickly as coil elements.
- In the event of a potential boilover, remove the pan from the cooking surface.
- **Never attempt to lift the cooktop.**
- The smoothtop surface may appear discolored when it is hot. This is normal and will disappear when the surface cools.

## Cooking Areas

The cooking areas on your range are identified by permanent circles on the smoothtop surface. For most efficient cooking, fit the pan size to the element size.

**Pans should not extend more than 1/2 to 1-inch beyond the cooking area.**

When a control is turned on, a glow can be seen through the smoothtop surface. **The element will cycle on and off to maintain the preset heat setting, even on High.**

For more information on cookware, refer to *Cookware Recommendations* below.

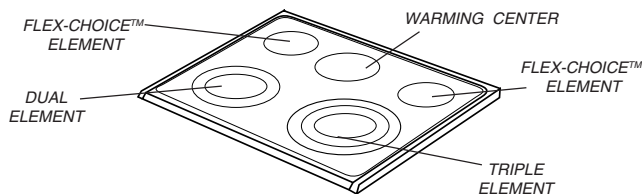

## Hot Surface Light

The Hot Surface indicator light is located on the control panel. The light will be illuminated when any cooking area is hot. It will remain on, even after the control is turned off, until the area has cooled.

## Tips to Protect the Smoothtop Surface

### Cleaning (see page 6 for more information)

- Before first use, clean the cooktop.
- Clean your cooktop daily or after each use. This will keep your cooktop looking good and can prevent damage.
- If a spillover occurs while cooking, immediately clean the spill from the cooking area while it is hot to prevent a tough cleaning chore later. Using extreme care, wipe spill with a clean dry towel.
- **Do not** allow spills to remain on the cooking area or the cooktop trim for a long period of time.
- **Never** use abrasive cleansing powders or scouring pads which will scratch the cooktop.
- **Never** use chlorine bleach, ammonia or other cleansers not specifically recommended for use on glass-ceramic.

### To Prevent Marks & Scratches

- **Do not** use glass pans. They may scratch the surface.
- **Never** place a trivet or wok ring between the surface and pan. These items can mark or etch the top.
- **Do not** slide aluminum pans across a hot surface. The pans may leave marks which need to be removed promptly. (See *Cleaning*, page 6.)
- Make sure the surface and the pan bottom are clean *before* turning on to prevent scratches.
- To prevent scratching or damage to the glass-ceramic top, **do not** leave sugar, salt or fats on the cooking area. Wipe the cooktop surface with a clean cloth or paper towel before using.
- **Never** slide heavy metal pans across the surface since these may scratch.

## To Prevent Stains

- **Never** use a soiled dish cloth or sponge to clean the cooktop surface. A film will remain which may cause stains on the cooking surface after the area is heated.
- Continuously cooking on a soiled surface may/will result in a permanent stain.

## To Prevent Other Damage

- **Do not** allow plastic, sugar or foods with high sugar content to melt onto the hot cooktop. Should this happen, clean immediately. (See *Cleaning*, page 6.)
- **Never** let a pan boil dry as this will damage the surface and pan.
- **Never** use cooktop as a work surface or cutting board.
- **Never** cook food directly on the surface.
- **Do not** use a small pan on a large element. Not only does this waste energy, but it can also result in spillovers burning onto the cooking area which requires extra cleaning.
- **Do not** use non-flat specialty items that are oversized or uneven such as round bottom woks, rippled bottom and/or oversized canners and griddles.
- **Do not** use foil or foil-type containers. Foil may melt onto the glass. If metal melts on the cooktop, **do not** use. Call an authorized servicer.

## Cookware Recommendations

Using the right cookware can prevent many problems, such as food taking longer to cook or achieving inconsistent results. Proper pans will reduce cooking times, use less energy, and cook food more evenly.

### Flat Pan Tests

See if your pans are flat.

#### The Ruler Test:

1. Place a ruler across the bottom of the pan.
2. Hold it up to the light.
3. Little or no light should be visible under the ruler.

#### The Bubble Test:

1. Put 1 inch of water in the pan. Place on cooktop and turn control to **High**.
2. Watch the formation of the bubbles as the water heats. Uniform bubbles mean good performance, and uneven bubbles indicate hot spots and uneven cooking.

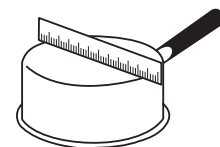

**Cont.**

Select	Avoid
Flat, smooth-bottom pans.	Pans with grooved or warped bottoms. Pans with uneven bottoms do not cook efficiently and sometimes may not boil liquid.
Heavy-gauge pans.	Very thin-gauge metal or glass pans.
Pans that are the same size as the element.	Pans smaller or larger than the element by 1 inch.
Secure handles.	Cookware with loose or broken handles. Heavy handles that tilt the pan.
Tight-fitting lids.	Loose-fitting lids.
Flat bottom woks.	Woks with a ring-stand bottom.

## Canning and Oversize Cookware

**All canners and large pots must have flat bottoms and must be made from heavy-gauge materials.** This is critical on smoothtop surfaces. The base **must not** be more than 1 inch larger than the element.

When canners and pots do not meet these standards, cooking times may be longer, and cooktops may be damaged.

Some canners are designed with smaller bases for use on smoothtop surfaces.

**When canning, use the High heat setting only until the water comes to a boil** or pressure is reached in the canner. Reduce to the lowest heat setting that maintains the boil or pressure. If the heat is not turned down, the cooktop may be damaged.



## Oven Cooking

### Control Panel

Broil	Use for broiling and top browning.
Bake	Use for baking and roasting.
More+/Less-	Enters or changes time, oven temperature. Sets HI or LO broil.
Timer	Sets Timer.
Cook & Hold	Bakes for a preset time, then holds food warm for 1 hour.
Clean	Use to set self-clean cycle.
Favorite	Use to set and save a specific Cook & Hold procedure.
Clock	Use to set time-of-day clock.
Keep Warm	Use to keep cooked food warm in oven.
CANCEL	Cancel all operations except Timer and Clock.

### Using the Touchpads

- Press the desired pad.
- Press **More+** or **Less-** to enter time or temperature.
- A beep will sound when any pad is touched.
- A double beep will sound if a programming error occurs.

**Important:** Four seconds after pressing the More+ or Less- pads, the time or temperature will automatically be entered. If more than 30 seconds elapse between touching a function pad and the More+ or Less- pads, the function will be canceled and the display will return to the previous display.

### Clock

The clock can be set to display time in a 12-hour or 24-hour format. The clock is set at the factory for the 12-hour format.

#### To change the clock to 24-hour format:

1. Press and hold the **CANCEL** and **Favorite** pads for *three* seconds.
2. Press the **More+** or **Less-** pad to select 12 or 24 hour.
3. Set the time of day following the directions below.

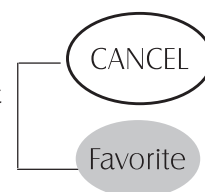

#### To set the Clock:

1. Press the **Clock** pad.
  - The colon flashes in the display.
2. Press **More+** or **Less-** to set the time of day.
  - Colon continues flashing.
3. Press the **Clock** pad again or wait *four* seconds. The colon stops flashing.

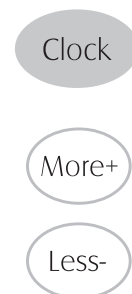

When electrical power is supplied or after a power interruption, the last clock time before power was interrupted will flash.

To recall the time of day when another time function is showing, press the **Clock** pad.

Clock time cannot be changed when the oven has been programmed for Delay Cook or Delay Clean or Cook & Hold.

#### To cancel the Clock display:

If you do not want the time of day to display:

Press and hold the **CANCEL** and **Clock** pads for *three* seconds. The time of day will disappear from the display

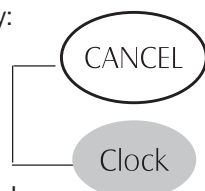

When the clock display is canceled, press the **Clock** pad to briefly display the time of day.

#### To restore the Clock display:

Press and hold the **CANCEL** and **Clock** pads for *three* seconds. The time of day will reappear in the display.

## Timer

The timer can be set from one minute (0:01) up to 99 hours and 59 minutes (99:59).

The timer can be used independently of any other oven activity. It can also be set while another oven function is operating.

The timer does not control the oven. It only controls a beeper.

### To set the Timer:

1. Press the **Timer** pad.
  - 0:00 lights in the display.
  - The colon will flash.
2. Press the **More+** or **Less-** pad until the correct time appears in the display.
  - The colon will continue to flash.
3. Press **Timer** pad again or wait *four* seconds.
  - The colon continues flashing and the time begins counting down.
  - The last minute of the timer countdown will be displayed as seconds.
4. At the end of the set time, one long beep will sound.

### To cancel the Timer:

1. Press and hold the **Timer** pad for *three* seconds.  
OR
2. Press the **Timer** pad and set the time to 0:00.

## Locking the Control and Oven Door

The touchpad controls and oven door can be locked for safety, cleaning, or to prevent unwanted use. They will not function when locked.

If the oven is currently in use, the controls and door cannot be locked.

The current time of day will remain in the display when the controls are locked.

### To lock:

Press and hold the **CANCEL** and **Cook & Hold** pads for *three* seconds. (Press **CANCEL** pad first.)

- LOCK flashes in the display.

### To unlock:

Press and hold the **CANCEL** and **Cook & Hold** pads for *three* seconds. (Press **CANCEL** pad first.)

- LOCK disappears from the display.

## Fault Codes

BAKE or LOCK may flash rapidly in the display to alert you if there is an error or a problem. If BAKE or LOCK flash in the display, press **CANCEL** pad. If BAKE or LOCK continue to flash, disconnect power to the appliance. Wait a few minutes,

and then reconnect power. If the flashing still continues, disconnect power to the appliance and call an authorized servicer.

## Baking

### To set Bake:

1. Press the **Bake** pad.
  - BAKE will flash.
  - 000 will light in the display.
2. Select the oven temperature. The oven temperature can be set from 170° to 550°. Press or press and hold the **More+** or **Less-** pad.
  - 350° will light when either pad is first pressed.
  - Press the **More+** pad to increase the temperature.
  - Press the **Less-** pad to decrease the temperature.
3. Press **Bake** pad again or wait *four* seconds.
  - BAKE will stop flashing and light in the display.



- 100° or the actual oven temperature will display. The temperature will rise in 5° increments until the preset temperature is reached.
4. Allow the oven to preheat for 8-15 minutes.
  - When the set oven temperature is reached, one long beep will sound.
  - To recall the set temperature during preheat, press the **Bake** pad.
5. Place food in the oven.
6. Check cooking progress at minimum cooking time. Cook longer if needed.
7. When cooking is finished, press **CANCEL** pad.
8. Remove food from the oven.

### Notes:

- To change the oven temperature during cooking, press the **Bake** pad and then the **More+** or **Less-** pad until you reach the desired temperature.
- To change the oven temperature during preheat, press the **Bake** pad *twice* and then the **More+** or **Less-** pad until you reach the desired temperature.
- If you forget to turn off the oven, it will automatically turn off at the end of 12 hours. If you wish to deactivate this feature, see page 16.

## Baking Differences Between Your Old and New Oven

It is normal to notice some baking time differences between a new oven and an old one. See *Adjusting the Oven Temperature* on page 16.

## Cook & Hold

Cook & Hold allows you to bake for a preset amount of time, followed by a one-hour Keep Warm cycle.

### To set Cook & Hold:

1. Press the **Cook & Hold** pad.
  - BAKE and HOLD flash.
  - 00:00 lights in the display.
2. Select the oven temperature. The oven temperature can be set from 170° to 550°. Press or press and hold the **More+** or **Less-** pad.
  - Press the **More+** pad to increase the temperature.
  - Press the **Less-** pad to decrease the temperature.
3. Press **Cook & Hold** pad again OR wait *four* seconds.
  - HOLD flashes.
  - 00:00 flashes in the display
4. Enter the amount of time you want to bake by pressing the **More+** or **Less-** pad. Bake time can be set from 10 minutes (00:10) to 11 hours, 59 minutes (11:59).
  - BAKE and HOLD light in the display.
  - The baking time will light in the display.
  - The baking time will start counting down.

### When the cooking time has elapsed:

- Four beeps will sound.
- BAKE will turn off.
- HOLD and WARM will light.
- 170° will display.



### After one hour in HOLD WARM:

- "End" will display.
- The time of day will reappear in the display.

### To cancel Cook & Hold at any time:

Press the **CANCEL** pad. Remove food from oven.



## Delay Cook & Hold



### CAUTION

**Do not** use delayed baking for highly perishable foods such as dairy products, pork, poultry, or seafood.

When using Delay, the oven begins to cook later in the day. Set the amount of time that you want to delay before the oven turns on and how long you want to cook. The oven begins to heat at the selected time and cooks for the specified length of time, then keeps food warm for one hour.

Delay time can be set from 10 minutes (00:10) to 11 hours, 59 minutes (11:59).

### To set a Delayed Cook & Hold cycle:

1. Press the **Bake** and **Timer** pads at the same time.
  - DELAY lights in the display.
  - 00:00 appears in the display.
2. Press the **More+** or **Less-** pad to set the delay time.
3. Press the **Cook & Hold** pad.
  - 00:00 lights in the display.
  - BAKE and HOLD flash.
4. Press **More+** to set the baking temperature.
  - 00:00 and HOLD flash.
  - BAKE stays lit.
5. Press **More+** to set the baking time.
  - The Delay time, DELAY, BAKE and HOLD light in the display.



### When the Delay time has expired:

- DELAY will turn off.
- Baking time and temperature are displayed.
- BAKE and HOLD are displayed.

### To set a Delay when Cook & Hold has already been programmed:

1. Press the **Bake** and **Timer** pads. (Press the **Bake** pad first).
  - DELAY and 00:00 appear in the display.
2. Press the **More+** or **Less-** pad to set the delay time.
  - DELAY will stay lit to remind you that a delayed cooking cycle has been set.

### When the Delay time has expired and the oven starts:

- The baking time and temperature are displayed.
- DELAY will turn off.
- BAKE and HOLD will remain lit.

### To cancel:

Press the **CANCEL** pad.

- All timed and untimed cooking functions will be canceled.
- The time of day will reappear in the display.

### Important:

- **Do not** use delayed baking for items that require a preheated oven, such as cakes, cookies, and breads.
- **Do not** use delayed baking if oven is already hot.

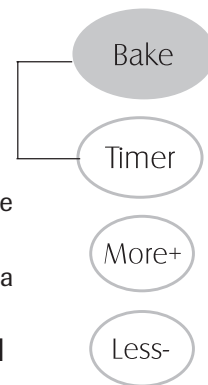
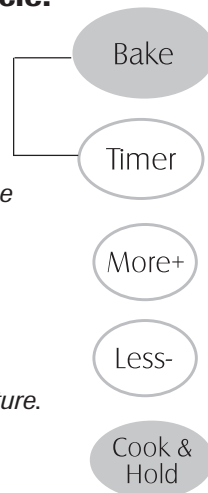
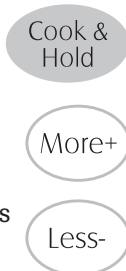

## Keep Warm

For safely keeping foods warm or for warming breads and plates.

### To set Keep Warm:

1. Press the **Keep Warm** pad.
  - WARM flashes.
  - 000 appears in the display.
2. Select the Keep Warm temperature. The Keep Warm temperature can be set from 145° to 190°. Press or press and hold the **More+** or **Less-** pad.
  - 170° will light when either pad is first pressed.
  - Press the **More+** pad to increase the temperature.
  - Press the **Less-** pad to decrease the temperature.

WARM and the temperature will be displayed while Keep Warm is active.



### To cancel Keep Warm:

1. Press the **CANCEL** pad.
2. Remove food from the oven.

### Notes:

- For optimal food quality, oven cooked foods should be kept warm for no longer than 1 to 2 hours.
- To keep foods from drying, cover loosely with foil or a lid.
- **To warm dinner rolls:**
  - cover rolls loosely with foil and place in oven.
  - press **Keep Warm** and **More+** pads to set 170° F.
  - warm for 12-15 minutes.
- **To warm plates:**
  - place 2 stacks of up to four plates each in the oven.
  - press **Keep Warm** and **More+** pads to set 170° F.
  - warm for five minutes, turn off the oven and leave plates in the oven for 15 minutes more.
  - use only oven-safe plates, check with the manufacturer.
  - **do not** set warm dishes on a cold surface as rapid temperature changes could cause crazing or breakage.

## Broiling

### CAUTION

Use CAUTION when cooking with the Broil feature. The grease from fatty foods may ignite. If a fire should occur, close the oven door and turn the oven **OFF**. If the fire does not extinguish, **DO NOT** put water on the fire. Use baking soda, dry chemical or fire extinguisher to smother the fire.

### To set Broil:

1. To begin, press the **Broil** pad.
  - BROIL flashes.
  - SEt is displayed.
2. Press the **More+** pad to set HI broil or press the **Less-** pad to set LO broil.
  - HI or LO will be displayed.
  - Select **HI broil** (550° F) for normal broiling. Select **LO broil** (450° F) for low-temperature broiling of longer cooking foods such as poultry.
3. After four seconds, the oven will start.
  - BROIL will remain lit.



4. For optimum browning, preheat broil element for 3-4 minutes *before* adding food.
5. Place food in the oven. Leave oven door open about four inches (the first stop).
6. Turn meat once about halfway through cooking.
7. When food is cooked, press the **CANCEL** pad. Remove food and broiler pan from the oven.
  - The time of day will reappear in the display.

### Notes:

- For best results when broiling, use a pan designed for broiling.
- Expect broil times to increase and browning to be slightly lighter if appliance is installed on a 208-volt circuit.
- HI is used for most broiling. Use LO broil when broiling longer cooking foods. The lower temperature allows food to cook to the well done stage without excessive browning.
- *To change oven temperature during broiling*, press the **Broil** pad and then the **More+** or **Less-** pad to switch between LO and HI broil.
- Broil times may be longer when the lower broiling temperature is selected.
- Most foods should be turned halfway through broiling time.

## Broiling Chart

FOODS	RACK POSITION	APPROX. TIME FIRST SIDE	APPROX. TIME SECOND SIDE
<b>Beef</b> Steak, 1" thick,      Medium Well Hamburgers, 3/4" thick,   Well	6 6 6 or 7	8 minutes 10 minutes 9 minutes	7 - 12 minutes 8 - 14 minutes 6 - 9 minutes
<b>Pork</b> Bacon Chops, 1" Ham Slice	6 6 6	6 - 10 minutes 10 - 11 minutes 5 minutes	(no turning) 12 - 14 minutes 3 - 7 minutes
<b>Poultry</b> Breast Halves	4	LO Broil 15 minutes	LO Broil 15 - 25 minutes
<b>Seafood</b> Fish Steaks, buttered, 1" thick Lobster Tails, 3-4 oz. each	6 5	10 - 15 minutes 7 - 10 minutes	(no turning) (no turning)

**Note:** This chart is a suggested guide. The times may vary with the food being cooked.

## Adjusting the Oven Temperature

Oven temperatures are carefully tested for accuracy at the factory. It is normal to notice some baking or browning differences between a new oven and an old one. As ranges get older, the oven temperature can shift.

You may adjust the oven temperature if you think the oven is not baking or browning correctly. To decide how much to change the temperature, set the temperature 25° higher or lower than your recipe recommends, then bake. The results of the "test" should give you an idea of how much to adjust the temperature.

### To adjust the oven temperature:

1. Press **Bake**.
2. Enter 550° by pressing the **More+** pad.
3. Press and hold the **Bake** pad for several seconds or until 0° appears in the display.

If the oven temperature was previously adjusted, the change will be displayed. For example, if the oven temperature was reduced by 15° the display will show "-15°".

4. Press the **More+** or **Less-** pad to adjust the temperature.

Each time a pad is pressed, the temperature changes by 5°. The oven temperature can be increased or decreased by 5° to 35°.

5. The time of day will automatically reappear in the display.

You do not need to readjust the oven temperature if there is a power failure or interruption. Broiling and cleaning temperatures cannot be adjusted.

## Automatic Shut-Off/ Sabbath Mode

The oven will automatically turn off after 12 hours if you accidentally leave it on. This safety feature can be turned off.

### To cancel the 12-hour shut-off and run the oven continuously for 72 hours:

1. Set the oven to bake (see page 13).
2. Press and hold the **Clock** pad for *five* seconds.
  - SAb will be displayed and flash for five seconds.
  - SAb will then be displayed continuously until turned off or until the 72-hour time limit is reached.
  - BAKE will also be displayed if a bake cycle is in use while the oven is in Sabbath Mode.
  - *BAKE is the only function that operates during the Sabbath Mode. All other functions (Timer, Keep Warm, Clean, etc.) are locked out during the Sabbath Mode.*

### To cancel Bake when in Sabbath Mode:

Press **CANCEL**.

- BAKE will turn off in the display.
- No beeps will sound.

### To cancel the Sabbath Mode:

1. Press the **Clock** pad for *five* seconds.
- OR
2. After 72 hours, the Sabbath Mode will end.
    - SAb will flash for five seconds.
    - The time of day will return to the display.

## Notes:

- Sabbath Mode can be turned on at any time with or without the oven on.
- Sabbath Mode cannot be turned on if the touchpads are locked out or when the door is locked.
- If the oven is baking when Sabbath Mode is set, BAKE will go out at the end of the baking cycle. There will be no audible beeps.
- If the oven light is desired while in Sabbath Mode, it must be turned on before the Sabbath Mode is started.
- When the Sabbath Mode is started, no preheat beep will sound.
- All prompts, messages and beeps are deactivated when Sabbath Mode is active.
- The automatic door lock does not operate during the Sabbath Mode.
- Pressing CANCEL will cancel a bake cycle, however the control will stay in the Sabbath Mode.
- If power fails, the oven will power up in Sabbath Mode with 72 hours remaining and no cycle active.

## Favorite

The Favorite pad allows you to save the time and temperature from a Cook & Hold function.

To set a Favorite cycle, Cook & Hold must be either active or just programmed.

### To set a new Favorite cycle or to save a currently running Cook & Hold as a Favorite:

1. Program a Cook & Hold cycle as described in the *Cook & Hold* section on page 14.
2. Press and hold the **Favorite** pad for *three* seconds.
  - The newly set or currently running Cook & Hold cycle will be saved.
  - A beep will sound to indicate that the control has accepted the Favorite setting.

Favorite

### To start a cycle programmed into Favorite:

1. Press the **Favorite** pad.
  - Time and temperature for the set Cook & Hold cycle will be displayed. (If no Cook & Hold cycle has been programmed, "nonE" is displayed.)
2. Press the **Bake** pad.
  - The Favorite cycle will begin immediately.
  - BAKE will light in the display
  - The cooking time will light in the display

Favorite

Bake

### When the cooking time has elapsed:

- BAKE will turn off.
- HOLD and WARM will light.
- 170° will display.

### To cancel a Favorite cycle in progress:

1. Press the **CANCEL** pad.
  - The stored Favorite cycle will not be affected.
2. Remove food from the oven.

CANCEL

## Changing Temp °F/°C

1. The factory default setting for temperature is Fahrenheit.
2. To change the setting, press and hold the **CANCEL** and **Bake** pads at the same time for *three* seconds.
3. A single beep will sound and the current setting will be displayed (°F or °C). (If no change is made, the range will return to the existing setting after 30 seconds.)
4. To change the setting, press the **More+** or **Less-** pad. Press again to return to existing setting. Wait *five* seconds and the setting will be complete.

## Oven Vent

When the oven is in use the area near the vent may become hot enough to cause burns. **Never** block the vent opening.

**The oven vent is located below the backguard vent shield on your range.**

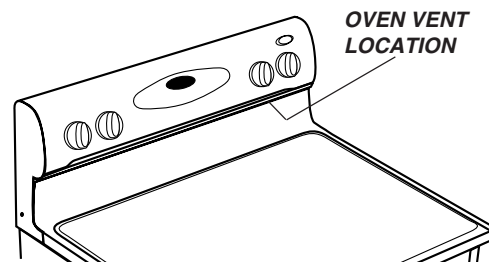

**Do not** place plastics near the vent opening as heat from the vent could distort or melt the plastic.

## Oven Light

The oven light automatically comes on when the door is opened. When the door is closed, press the **Oven Light** switch to turn the oven light on and off.



Oven Light

## Oven Bottom

Protect oven bottom against spillovers, especially acidic or sugary spills, as they may discolor the porcelain enamel. Use the correct pan size to avoid spillovers and boilovers. **Do not place utensils or aluminum foil directly on the oven bottom.**

# Oven Racks

## ⚠ CAUTION

- **Do not** attempt to change the rack position when the oven is hot.
- **Do not** use the oven for storing food or cookware.

The oven has two racks. All racks are designed with a lock-stop edge.

### To remove:

1. Pull rack straight out until it stops at the lock-stop position.
2. Lift up on the front of the rack and pull out.

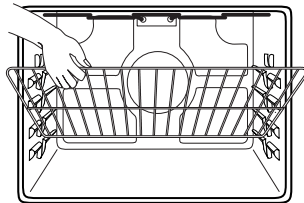

### To replace:

1. Place rack on the rack supports in the oven
2. Tilt the front end up slightly. Slide rack back until it clears the lock-stop position.
3. Lower front and slide back into the oven.

**Never cover an entire rack with aluminum foil or place foil on the oven bottom. Baking results will be affected and damage may occur to the oven bottom.**

## Rack Positions

**RACK 7** (highest position): For toasting bread or broiling thin, non-fatty foods.

**RACK 6:** Used for most broiling.

**RACK 5:** For two rack baking.

**RACK 4:** Used for most baked goods on a cookie sheet or jelly roll pan, fruit pies, or frozen convenience foods. Also use for broiling chicken pieces.

**RACK 3:** For casseroles, baking loaves of bread, bundt cakes or custard pies.

**RACK 2:** Used for roasting small cuts of meat, frozen pies, dessert souffles or angel food cake. Also use for two rack baking.

**RACK 1:** Used for roasting large cuts of meat and poultry.

**Oven Bottom:** Place oven rack on raised sides of oven bottom. Use for additional space when cooking large oven meals.

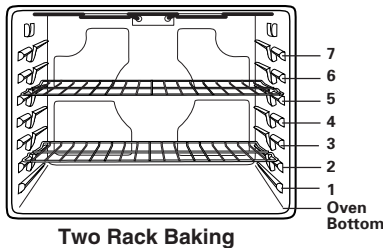

Two Rack Baking

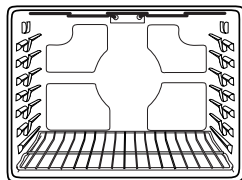

**MULTIPLE RACK COOKING: Two rack:** Use rack positions 2 and 5 or 3 and 6.

## Baking Layer Cakes on Two Racks

For best results when baking cakes on two racks, use racks 2 and 4.

Place the cakes on the rack as shown.

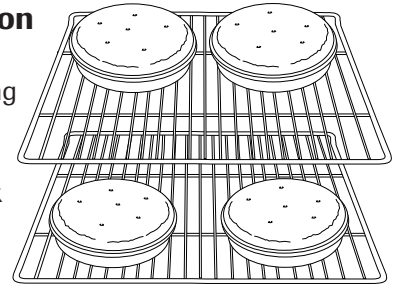

## Create-A-Space™ Half Rack

Select range models are equipped with a convertible half rack. The left side of the rack can be removed to accommodate a large roaster on the lower rack. The right side of the rack is still available to hold a casserole dish.

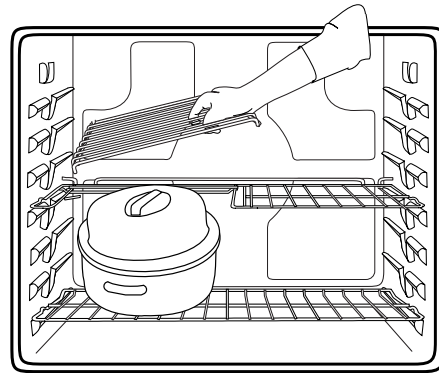
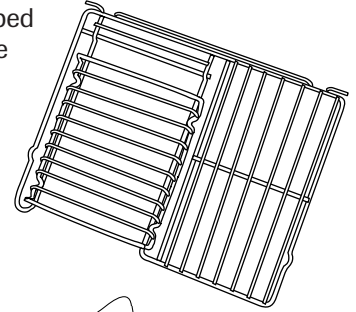

### Notes:

- The removable section of the rack can be used as a roasting rack in a broiling pan. **Do not** use the top insert when using the rack in a broiling pan.
- The removable section of the rack can be used as a cooling rack or trivet.
- Make sure oven is cool *before* removing or reinstalling the half rack.
- **Do not** use cookware that extends beyond edge of rack.
- For best results, allow two inches between the pan placed on the rack and the oven side wall.
- Use caution when removing items from the half rack to avoid burns.
- Carefully remove items from the lower rack to avoid disturbing the half rack.

---

# MAYTAG® MAJOR APPLIANCE WARRANTY

---

## LIMITED WARRANTY

For one year from the date of purchase, when this major appliance is operated and maintained according to instructions attached to or furnished with the product, Maytag brand of Whirlpool Corporation or Whirlpool Canada LP (hereafter "Maytag") will pay for factory specified parts and repair labor to correct defects in materials or workmanship. Service must be provided by a Maytag designated service company. This limited warranty is valid only in the United States or Canada and applies only when the major appliance is used in the country in which it was purchased. Outside the 50 United States and Canada, this limited warranty does not apply. Proof of original purchase date is required to obtain service under this limited warranty.

---

## ITEMS EXCLUDED FROM WARRANTY

### This limited warranty does not cover:

1. Service calls to correct the installation of your major appliance, to instruct you on how to use your major appliance, to replace or repair house fuses, or to correct house wiring or plumbing.
2. Service calls to repair or replace appliance light bulbs, air filters or water filters. Consumable parts are excluded from warranty coverage.
3. Repairs when your major appliance is used for other than normal, single-family household use or when it is used in a manner that is contrary to published user or operator instructions and/or installation instructions.
4. Damage resulting from accident, alteration, misuse, abuse, fire, flood, acts of God, improper installation, installation not in accordance with electrical or plumbing codes, or use of consumables or cleaning products not approved by Maytag.
5. Cosmetic damage, including scratches, dents, chips or other damage to the finish of your major appliance, unless such damage results from defects in materials or workmanship and is reported to Maytag within 30 days from the date of purchase.
6. Any food loss due to refrigerator or freezer product failures.
7. Costs associated with the removal from your home of your major appliance for repairs. This major appliance is designed to be repaired in the home and only in-home service is covered by this warranty.
8. Repairs to parts or systems resulting from unauthorized modifications made to the appliance.
9. Expenses for travel and transportation for product service if your major appliance is located in a remote area where service by an authorized Maytag servicer is not available.
10. The removal and reinstallation of your major appliance if it is installed in an inaccessible location or is not installed in accordance with published installation instructions.
11. Major appliances with original model/serial numbers that have been removed, altered or cannot be easily determined. This warranty is void if the factory applied serial number has been altered or removed from your major appliance.

The cost of repair or replacement under these excluded circumstances shall be borne by the customer.

---

## DISCLAIMER OF IMPLIED WARRANTIES; LIMITATION OF REMEDIES

CUSTOMER'S SOLE AND EXCLUSIVE REMEDY UNDER THIS LIMITED WARRANTY SHALL BE PRODUCT REPAIR AS PROVIDED HEREIN. IMPLIED WARRANTIES, INCLUDING WARRANTIES OF MERCHANTABILITY OR FITNESS FOR A PARTICULAR PURPOSE, ARE LIMITED TO ONE YEAR OR THE SHORTEST PERIOD ALLOWED BY LAW. MAYTAG SHALL NOT BE LIABLE FOR INCIDENTAL OR CONSEQUENTIAL DAMAGES. SOME STATES AND PROVINCES DO NOT ALLOW THE EXCLUSION OR LIMITATION OF INCIDENTAL OR CONSEQUENTIAL DAMAGES, OR LIMITATIONS ON THE DURATION OF IMPLIED WARRANTIES OF MERCHANTABILITY OR FITNESS, SO THESE EXCLUSIONS OR LIMITATIONS MAY NOT APPLY TO YOU. THIS WARRANTY GIVES YOU SPECIFIC LEGAL RIGHTS, AND YOU MAY ALSO HAVE OTHER RIGHTS WHICH VARY FROM STATE TO STATE OR PROVINCE TO PROVINCE.

---

If outside the 50 United States and Canada, contact your authorized Maytag dealer to determine if another warranty applies.

If you need service, first see the "Troubleshooting" section of the Use & Care Guide. After checking "Troubleshooting," you may find additional help by checking the "Assistance or Service" section or by calling Maytag. In the U.S.A., call **1-800-688-9900**. In Canada, call **1-800-807-6777**.

9/07